



848ER893A0 (804)



# OWNER'S MANUAL

**Model: G240RC/G270RC**

**Model code: X374323111 (G240RC)**

**Model code: X374326111 (G270RC)**

**Thank you for using ZENOAH ENGINE.**

- **Please read this Owner's Manual thoroughly before operating and use the engine correctly according to this Owner's Manual.  
(For safety reasons, please contact your sales dealer before operating this engine if there is something that you do not understand.)**
- **This engine has been designed for the use of radio control car.  
Please use this engine in conjunction with the manual for radio control car or radio control equipment you are going to use.**
- **Any modification of the engine or any use of other applications is prohibited.**
- **The purchaser (user) shall bear all obligations and responsibilities stipulated by law, local ordinance and the likes.  
Husqvarna Zenoah Co., Ltd. shall bear no responsibility whatsoever.**

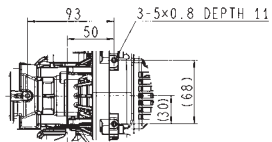
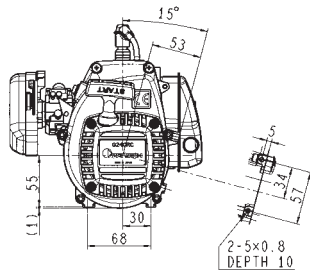
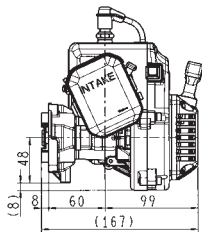
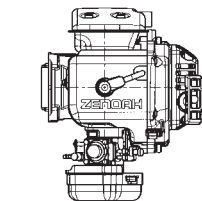
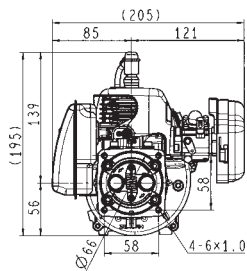

# CONTENTS

---

---

SPECIFICATIONS.....	4
SAFETY PRECAUTIONS.....	5
FUEL .....	7
ENGINE STARTING.....	8
OPERATION .....	9
MAINTENANCE .....	10
SPECIAL TOOLS .....	15
SERVICE GUIDE .....	16
TROUBLE SHOOTING .....	19
PARTS LIST (G240RC).....	22
PARTS LIST (G270RC).....	26
WARRANTY .....	30

# SPECIFICATIONS

---

---

Engine Type	G240RC	G270RC
Overall Size (L x W x H)	166 x 205 x 196mm	
Weight	2.07kg	
Displacement	22.5cm <sup>3</sup>	25.4cm <sup>3</sup>
Clutch Engagement	6000rpm (STD Spring)	
Carburetor Type	WT-813A	
Spark Plug	NGK CMR7H	
Spark Plug Gap	0.65mm	
Rotating Direction	Counter-Clockwise (View From PTO)	

## **⚠ SAFETY PRECAUTIONS ⚠**

---

- **These safety precautions are to prevent you and those people in the vicinity from incurring harm or damage. Make sure to observe these precautions and constantly strive to ensure safety.**
- **Safe use of the engine is your personal obligation and responsibility. Constantly take care to act with good judgment as you enjoy your hobbies.**
  
- **The fuel is toxic. Do not let it get into your eyes or mouth. Store it in a cool place, out of the reach of infants and children.**
- **Use of open flames around the fuel is strictly prohibited, because of danger of fire.**
- **To prevent burns, make sure not to touch the engine while it is operating or immediately after it has stopped.**
- **Do not run the motor in poorly ventilated places. Do not breathe the exhaust, as it is a health hazard.**
- **Please wear clothing that facilitates your safety. Remove all scarves,**

## **⚠ SAFETY PRECAUTIONS ⚠**

---

overly long sleeves, neckties and the like. Failure to do so could result in injury.

- **When mounting the engine to a model, make sure to follow the model's operating manual. If necessary, reinforce the engine mounting unit and the peripheral parts.**

## FUEL

---

- Mix gasoline (octane over 95) and high grade 2 cycle engine oil (mixing use type; F3C grade or ISO EGC grade) at mixing ratio 25~40:1.
- The mixing ratio is according to the oil recommendation.

### [ NOTE ]

- 1) Never use any alcohol fuel or alcohol added fuel, or the rubber parts in the carburetor and engine will be damaged.
- 2) Gasoline is very flammable. Avoid smoking and any fires near fuel.
- 3) To prevent all possible problems on fueling system, make sure to use the fuel filter which has more than 300 mesh or equivalent and gasoline proof rubber pipe or equivalent.

Incorrect fuel filter may cause engine trouble like fuel passage stuffing in carburetor, or piston surface scratching etc.

# ENGINE STARTING

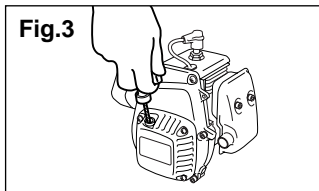
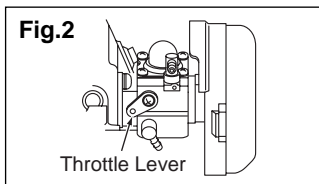
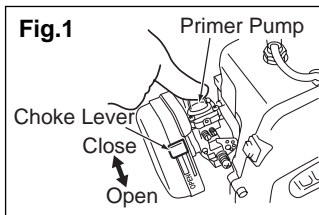

- Push the primer pump several times until overflow fuel flows out. (Fig.1)
- Close the choke lever, and move the throttle lever 1/4~1/3 open position. (Fig.1)(Fig.2)
- Pull the starter(knob) quickly until first firing noise. (Fig.3)
- Open the choke(Fig.2), throttle idle~1/4 open
- Pull the starter quickly
- Operate engine for a few minutes for the warming up.

## ! IMPORTANT

- In case of engine warm condition, choking may not be necessary.
- Over choking may cause starting difficulty due to wet spark plug.  
In this case change spark plug or dry it, and remove fuel rest in the cylinder by pulling starter.



## **OPERATION**

---

---

- This engine is already tuned up to get high power and high speed, and needs correct maintenance to keep such high performance.
- The details for operation may be described in the separate owners manual to be issued by car manufacturer.
- Be sure to have the engine cool down for 30 seconds at idle speed after full throttle running.

# MAINTENANCE

## 1) MAINTENANCE CHART

Items	Action	Before Use	Every 25 hours	Every 100 hours	Note
Leakage, Damage/Crack	Check	✓			
Idling Speed	Check/Adjust	✓	✓	✓	
Air-cleaner	Check/Cleaning	✓	✓		Replace if necessary
Spark Plug(gap)	Check/Adjust		✓	✓	↑
Cylinder(barrel)	Check/Cleaning		✓	✓	↑
Piston, Ring	Check/Cleaning		✓	✓	↑
Muffler & Bolt	Check/Cleaning	✓	✓	✓	↑
Bearings	Check/Cleaning		✓	✓	↑
Crank Shaft	Check/Alignment			✓	↑

# MAINTENANCE

## 2) SPECIFICATIONS AND TECHNICAL DATA

Items	Unit	G240RC	G270RC	Remarks
Bore x Stroke	mm	32 x 28	34 x 28	
Displacement	cm <sup>3</sup>	22.5	25.4	
Effective Compression Ratio		8.9	8.9	
Carburetor	Type	Walbro WT	←	
	Venture(mm)	ø12.7	←	
Starting		Recoil Starter	←	
Ignition	Type	TCI	←	
	Timing	BTC 30°/8000rpm	←	
Spark Plug	Standard	CMR7H	←	NGK
	Option(For Race)	CR8HIX with Terminal Nut	←	↑
	Option(Hot Type)	CMR6H	←	↑
Clutch Engagement Speed	rpm	6000	←	
No load max Speed	rpm	19500	←	
Idling Speed	rpm	4000	←	
Max. Power	kW/rpm	1.77/12000	1.80/12000	
Max. Torque	N.m/rpm	1.56/9000	1.61/9000	
Fuel Consumption	g/kW-h	616	653	
Carburetor	H	1 1/8 ± 1/4	←	
Standard setting	L	1 1/4 ± 1/4	←	

# MAINTENANCE

## 3) MAINTENANCE SPECIFICATIONS

	Items	G240RC		G270RC		Measuring Device	Remarks
		Standard	Limit	Standard	Limit		
Cylinder	Bore (mm)	ø32	Plating damaged	ø34	Plating damaged	Eye Checking	
Piston	Diameter (mm)	ø31.97	ø31.87	ø33.97	ø33.87	Micro Meter	At the skirt end and the right angle to the piston pin.
	Piston Ring Groove width (mm)	0.81	0.91	1.01	1.11	Thickness Gauge	
	Piston Pin Hole (mm)	ø8.01	ø8.05	ø8.01	ø8.05	Cylinder Gauge	
	Clearance between Piston and Cylinder (mm)	0.03~0.06	0.15	0.03~0.06	0.15	Micro Meter Cylinder Gauge	
	Clearance between Groove and Piston Ring (mm)	0.02~0.04	0.1	0.02~0.04	0.1	Thickness Gauge	
Piston Ring	End Gap (mm)	0.05~0.25	0.5	0.05~0.25	0.5	Thickness Gauge	When inserted in a new cylinder.
	Width (mm)	0.78	0.73	0.98	0.93	Micro Meter	
	Piston Pin Diameter (mm)	ø8	ø7.98	ø8	ø7.98	Micro Meter	
	Connecting Rod Small end (mm)	ø11	ø11.05	ø11	ø11.05	Cylinder Gauge	
Crankshaft Dia. at Main Bearing (mm)		ø12	ø11.98	ø12	ø11.98	Micro Meter	
	Eccentricity (mm)	—	0.07	—	0.07	Dial Gauge	
	Axial Play (mm)	—	0.5	—	0.5	Thickness Gauge	
	Main Bearing	—	Gritty or Feels Flat Spot	—	Gritty or Feels Flat Spot	—	

# MAINTENANCE

## 4) CARBURETOR

Items	Standard	Limit	Measuring Device	Remarks
Metering Lever set (mm)	1.65	± 0.16	Vanier	
Inlet Valve Opening Pressure (kg/cm <sup>2</sup> )	1.3~2.3		Leak Tester	
Inlet Valve Closing Pressure (kg/cm <sup>2</sup> )	0.7~1.7		Leak Tester	

## 5) IGNITION SYSTEM



Items	Standard	Limit	Measuring Device	Remarks	
Spark Plug Air Gap (mm)	0.6~0.7	0.7	Thickness Gauge		
Ignition Coil/Flywheel Air Gap (mm)	0.3	0.4	Thickness Gauge		
Coil Resistance (Ω)	Primary	0.7	—	Volt Meter	Reading between primary terminal and iron core.
	Secondary	6100	—	Volt Meter	Reading between sparking cord end and iron core.

# MAINTENANCE

## 6) TIGHTENING TORQUE

Items	Screw Size	Standard (N-m)	Limit (N-m)	Remarks
Carburetor	M5 (P=0.8)	3.4	2.9~3.9	
Insulator	M5 (P=0.8)	4.4	3.9~4.9	with Locktight glue
Clutch	M6 (P=1.0)	6.4	4.9~7.8	
Rotor	M8 (P=1.0)	12.7	9.8~14.7	
Cylinder	M5 (P=0.8)	6.8	4.7~8.8	
Crankcase	M5 (P=0.8)	6.4	4.9~7.8	
Spark Plug	M10 (P=1.0)	10.8	8.8~12.8	
Muffler	M5 (P=0.8)	8.8	6.9~9.8	
Fan Cover	M5 (P=0.8)	3.4	2.9~3.9	
Ignition Coil	M4 (P=0.7)	3.2	2.5~3.9	
Starter Case	M4 (P=0.7)	1.3	1.0~1.5	
Tapping Screw	TP 4.3	2.4	1.9~2.9	

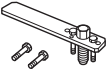
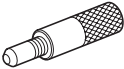
## SPECIAL TOOLS

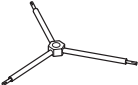
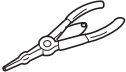
	Part Name	Part No.	External Appearance	Usage
1	Puller Assy	2890-96100		To remove rotor.
2	Piston Stopper	4810-96220		To hold crankshaft when disassembling/assembling clutch and rotor.
3	Rod Assy	1101-96220		To remove/install piston pin.
4	Air Gap Gauge	3330-97310		To set ignition coil.
5	Hex Wrench	3304-97611		For socket screw of Hex. 3mm, 4mm and 5mm.
6	Snap Ring Pliers	5500-96110		To remove snap ring.

# SERVICE GUIDE

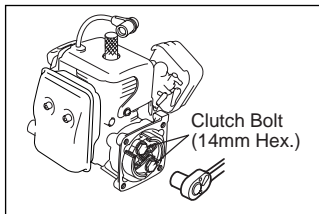

## 1) REMOVING CLUTCH SHOE

1. Remove the housing and plug cap.
2. Remove the spark plug and fit the stopper(4810-96220) into the plug hole.
3. Remove clutch bolts(14mm Hex.).

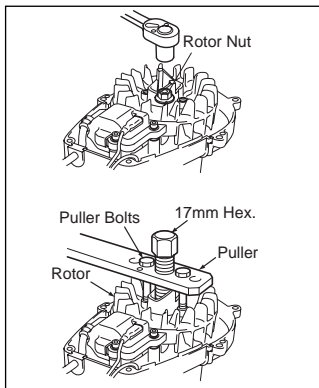

## 2) REMOVING ROTOR (FAN)

4. Remove the rotor nut(12mm Hex.).
5. Remove the rotor using the puller assy (2890-96100). Apply 8mm puller bolts.



# SERVICE GUIDE

---

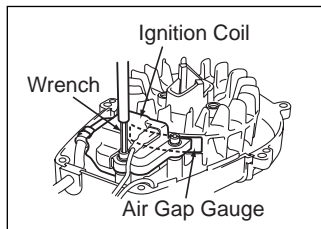

## 3) ASSEMBLING ROTOR

Insert the gauge(3330-97310) in between the rotor magnet metal and the coil.Tighten screws while pressing the coil against the rotor.

**Air Gap 0.3 ~ 0.4mm**

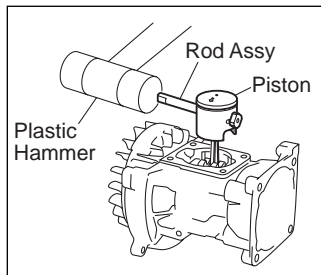

## 4) REMOVING PISTON PIN

1. Remove snap rings from both sides of the piston pin.
2. Engage the rod assy(1101-96220) to the piston pin and gently tap with a plastic hammer to push out the pin while holding piston firmly.



### NOTE

**Hard hammering may damage the big end of the connecting rod.**

# SERVICE GUIDE

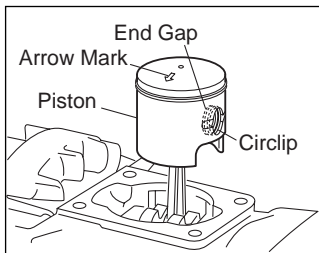

## 5) INSTALLING PISTON

1. Make sure to point the arrow mark on the piston to the exhaust side.
2. Fit the circlip in the groove so as to face the end gap below.



### NOTE

**Deformed circlip may come off during engine operation and damage the engine.**

## 6) CARBURETOR ADJUSTMENT

The carburetor comes with a standard setting, it is for optimum performance under the barometric pressure and climatic conditions at factory, so it may be re-adjusted according to load applied.

**Idle rpm : 4000  $\pm$  300 rpm (STD Spring)**

**H needle : 1 1/8  $\pm$  1/4**

**L needle : 1 1/4  $\pm$  1/4**

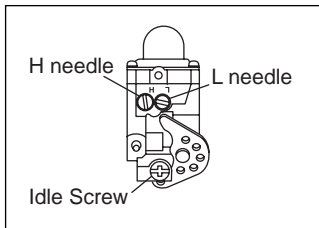

# TROUBLE SHOOTING

## 1) ENGINE DOES NOT START

Description	Cause	Countermeasure
No spark in the spark plug		
Spark Plug	1. Wet spark plug electrodes	Make them dry
	2. Carbon deposited on the electrodes	Cleaning
	3. Insulation failure by insulator damage	Exchange
	4. Inproper spark gap	Adjust to 0.6~0.7mm
	5. Burn out of electrodes	Exchange
Magneto	1. Ignition coil inside failure	Exchange
	2. Damaged cable sheath or disconnected cable	Exchange or repair
Switch	1. Switch is OFF	ON the switch
	2. Switch failure	Exchange
	3. Primary wiring earthed	Repair
Sparks appear in the spark plug		
Compression & fueling is normal	1. Over sucking of fuel	Drain excess fuel
	2. Too rich fuel	Adjust carburetor
	3. Overflow	Carburetor adjust or exchange
	4. Clogging of air cleaner	Wash with mixed gasoline
	5. Faulty fuel	Change with proper fuel
Fueling normal but poor compression	1. Worn out cylinder, piston, or piston ring	Exchange
	2. Gas leakage from cylinder and crank case gasket	Apply liquid gasket and reassemble.
No fuel supply	1. Choked breather air hole	Cleaning
	2. Clogged carburetor	Cleaning
	3. Clogged fuel filter	Exchange fuel filter

# TROUBLE SHOOTING

## 2) LACK OF POWER OR UNSTABLE RUNNING

Description	Cause	Countermeasure
Compression is normal and no misfire	1. Air penetration from fuel pipe joints, etc	Secure connection
	2. Air penetration from intake tube joint or carburetor joint	Change gasket or tightening screws
	3. Water in fuel	Change with good fuel
	4. Piston start to seizure	Replace piston(and cylinder)
	5. Muffler choked with carbon	Cleaning
Overheating	1. Fuel too lean	Adjust carburetor
	2. Clogging of cylinder fin with dust	Cleaning
	3. Poor fuel quality	Exchange with proper fuel
	4. Carbon deposited in the combustion chamber	Cleaning
	5. Spark plug electrode red hot	Thoroughly clean, adjust spark gap [ 0.6~0.7(0.023~0.028in) ]
Others	1. Dirty air cleaner	Wash with mixed gasoline
	2. Over loading	Reduce load

---

# **PARTS LIST**

# PARTS LIST G240RC (X374323111)

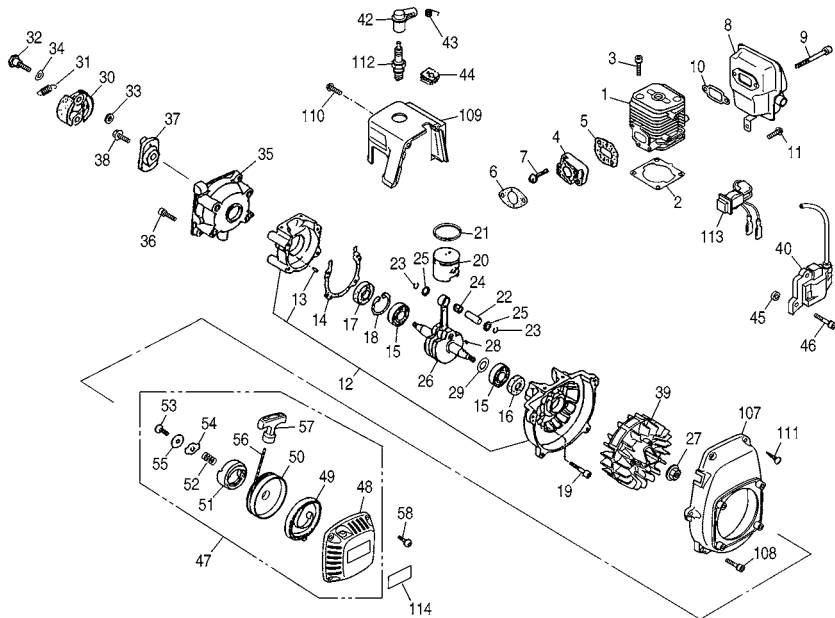

# G240RC (X374323111)

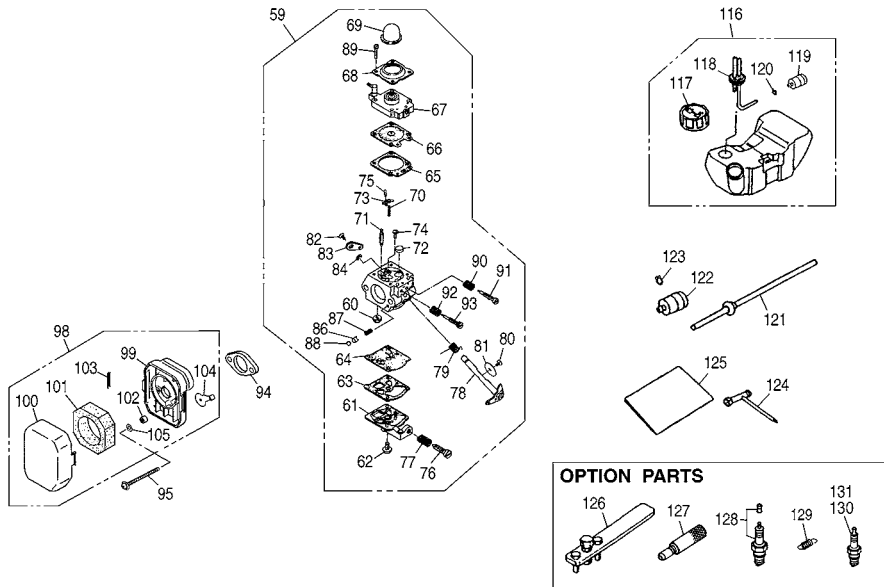

# PARTS LIST G240RC (X374323111)

KEY#	PART NUMBER	DESCRIPTION	Q'TY/ UNIT	REMARKS	KEY#	PART NUMBER	DESCRIPTION	Q'TY/ UNIT	REMARKS
1	848ER812A0	CYLINDER	1		35	1140-21162	CASE, CLUTCH	1	
2	T2075-13120	GASKET	1		36	3350-15250	BOLT	4	M5x16L
3	3310-12281	BOLT	4	M5x20L	37	1140-55310	PLATE	1	
4	1148-13162	INSULATOR	1		38	0224-30614	BOLT	1	M6x14L
5	848ER814B0	GASKET, INSU	1		39	T2070-71110	ROTOR	1	
6	T2075-14120	GASKET, CARB	1		40	T2070-71200	COIL-A	1	
7	3310-12281	BOLT	2	M5x20L					
8	T2070-15110	MUFFLER	1		42	T2075-72210	CAP	1	
9	01252-30550	BOLT	2	M5x50L	43	1400-72121	SPRING	1	
10	1140-13141	GASKET, MUFFLER	1		44	5500-72130	GROMMET	1	
11	1850-32160	SCREW	1	M4x12L	45	1260-71261	SPACER	2	
12	848ER82110	CRANKCASE-C	1		46	3350-14150	BOLT	2	M4x20L
13	2629-21130	• PIN	3		47	T2070-75101	RECOIL-A	1	
14	5500-21141	GASKET, CASE	1		48	T2070-75110	• CASE	1	
15	1155-21240	BEARING	2		49	5990-75120	• SPRING, SPIRAL	1	
16	2169-21210	SEAL	1		50	5990-75131	• REEL	1	
17	06034-06001	BEARING	1		51	5990-75141	• RATCHET	1	
18	04065-02812	RING	1		52	5990-75151	• SPRING, BREAK	1	
19	01252-30530	BOLT	4	M5x30L	53	5990-75270	• SCREW	1	
20	T2071-41110	PISTON	1		54	5990-75160	• RETAINER	1	
21	T2071-41210	RING	1		55	5990-75170	• WASHER	1	
22	1101-41310	PIN	1		56	1861-75180	• ROPE	1	
23	1260-41320	RING	2		57	1490-75181	• KNOB	1	
24	5500-41410	BEARING	1		58	0263-90416	SCREW	4	M4x16L
25	1101-41340	WASHER	2		59	848ETZ8101	CARBURETOR-A	1	WT-813A
26	T2070-42001	CRANKSHAFT-C	1		60	3306-81380	• SCREEN	1	
27	1650-43230	NUT	1	M8x1.0	61	3080-81120	• COVER	1	
28	1000-43240	KEY	1		62	3310-81130	• SCREW	1	
29	1140-43250	SIM	1		63	3304-81140	• GASKET	1	
30	1140-51111	SHOE	2		64	1172-81150	• DIAPHRAGM	1	
31	T2070-51220	SPRING (6000rpm IN)	1		65	1751-81470	• GASKET	1	
32	1140-51250	SCREW	2	M6x22L	66	3310-81260	• DIAPHRAGM	1	
33	1140-51230	WASHER	2		67	T2070-81210	• BODY-A	1	
34	1140-51242	WASHER	2		68	1751-81520	• COVER	1	



## G240RC (X374323111)

KEY#	PART NUMBER	DESCRIPTION	Q'TY/ UNIT	REMARKS	KEY#	PART NUMBER	DESCRIPTION	Q'TY/ UNIT	REMARKS
69	1751-81510	• PUMP	1		104	848ER883C0	• VALVE	1	
70	2867-81270	• SPRING	1		105	1918-82160	• WASHER	1	
71	3356-81310	• VALVE inlet	1		107	T2070-31111	COVER, FAN	1	
72	1480-81420	• PLUG welch	1		108	3310-12281	BOLT	4	M5x20L
73	3310-81230	• LEVER	1		109	848ER83111	COVER-A	1	
74	3310-81240	• SCREW	1		110	1850-32160	SCREW	1	M4x12L
75	3310-81250	• PIN	1		111	1900-31410	SCREW	2	TP4.5x18L
76	2630-81330	• SCREW	1		112	3699-91867	SPARKPLUG NGK CMR7H	1	
77	3350-81380	• SPRING	1		113	T2070-72200	SWITCH-A	1	
78	848ETZ81T1	• SHAFT throttle	1		114	848ER890C0	LABEL, RECOIL	1	
79	2670-81410	• SPRING	1		116	1726-85004	TANK-A	1	OP
80	2880-81470	• SCREW	2		117	5601-85201	• CAP-A	1	OP
81	3310-81340	• VALVE throttle	1		118	1726-85601	• PIPE COMP	1	OP
82	3310-81360	• SCREW	1		119	5500-85400	• FILTER	1	OP
83	1790-81440	• LEVER throttle	1		120	1260-85460	• CLIP	1	OP
84	1148-81390	• RING	1		121	1799-85400	PIPE COMP	1	
86	2812-81510	• PISTON	1		122	5500-85400	FILTER	1	
87	2810-81530	• SPRING	1		123	1260-85460	CLIP	1	
88	2812-81520	• BALL	1		124	T3039-91310	SOCKET	1	
89	1148-81530	• SCREW	4		125	T2070-93112	MANUAL	1	
90	1491-81160	• SPRING	1		126	2890-96100	PULLER-A	1	OP
91	1148-81171	• NEEDLE low speed	1		127	4810-96220	STOPPER	1	OP
92	3080-81320	• SPRING	1		128	848ETZ7110	SPARKPLUG NGK CR8HIX with Terminal Nut	1	OP
93	T2070-81330	• NEEDLE high speed	1		129	1764-51220	SPRING (5000rpm IN)	1	OP
94	T2070-82510	SPACER	1		130	3699-91975	SPARKPLUG NGK CMR6H	1	OP
95	0263-90560	SCREW	2	M5x60L	131	3699-91809	SPARKPLUG Champion RZ7C	1	OP
98	848ER88300	CLEANER-A	1						
99	T1000-82110	• HOUSING	1						
100	5730-82040	• COVER	1						
101	1751-82020	• FILTER	1						
102	5730-82060	• SLEEVE	2						
103	848EP183Y0	• CLIP	1						

# PARTS LIST G270RC (X374326111)

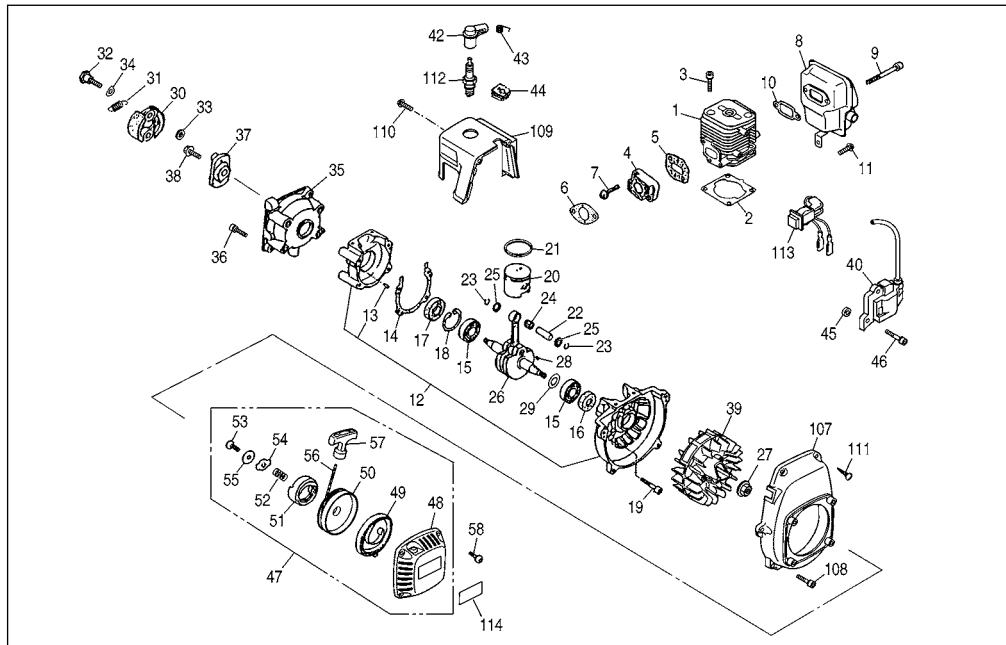

# G270RC (X374326111)

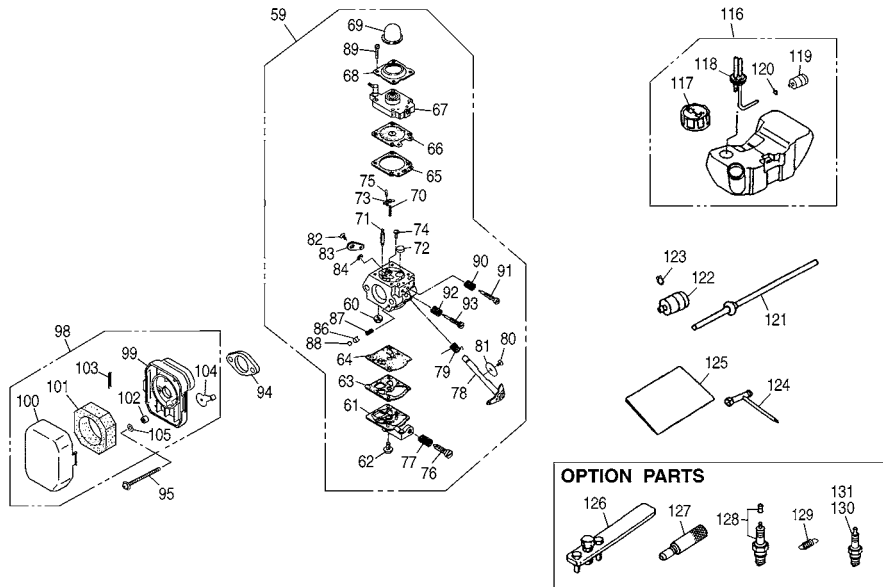

# PARTS LIST G270RC (X374326111)

KEY#	PART NUMBER	DESCRIPTION	Q'TY/ UNIT	REMARKS	KEY#	PART NUMBER	DESCRIPTION	Q'TY/ UNIT	REMARKS
1	848ET812A0	CYLINDER	1		35	1140-21162	CASE, CLUTCH	1	
2	T2075-13120	GASKET	1		36	3350-15250	BOLT	4	M5x16L
3	3310-12281	BOLT	4	M5x20L	37	1140-55310	PLATE	1	
4	1148-13162	INSULATOR	1		38	0224-30614	BOLT	1	M6x14L
5	848ER814B0	GASKET, INSU	1		39	T2070-71110	ROTOR	1	
6	T2075-14120	GASKET, CARB	1		40	T2070-71200	COIL-A	1	
7	3310-12281	BOLT	2	M5x20L					
8	T2070-15110	MUFFLER	1		42	T2075-72210	CAP	1	
9	01252-30550	BOLT	2	M5x50L	43	1400-72121	SPRING	1	
10	1140-13141	GASKET, MUFFLER	1		44	5500-72130	GROMMET	1	
11	1850-32160	SCREW	1	M4x12L	45	1260-71261	SPACER	2	
12	848ER82110	CRANKCASE-C	1		46	3350-14150	BOLT	2	M4x20L
13	2629-21130	• PIN	3		47	T2070-75101	RECOIL-A	1	
14	5500-21141	GASKET, CASE	1		48	T2070-75110	• CASE	1	
15	1155-21240	BEARING	2		49	5990-75120	• SPRING, SPIRAL	1	
16	2169-21210	SEAL	1		50	5990-75131	• REEL	1	
17	06034-06001	BEARING	1		51	5990-75141	• RATCHET	1	
18	04065-02812	RING	1		52	5990-75151	• SPRING, BREAK	1	
19	01252-30530	BOLT	4	M5x30L	53	5990-75270	• SCREW	1	
20	T2088-41110	PISTON	1		54	5990-75160	• RETAINER	1	
21	T2088-41210	RING	1		55	5990-75170	• WASHER	1	
22	1600-41310	PIN	1		56	1861-75180	• ROPE	1	
23	1260-41320	RING	2		57	1490-75181	• KNOB	1	
24	5500-41410	BEARING	1		58	0263-90416	SCREW	4	M4x16L
25	1101-41340	WASHER	2		59	848ETZ8101	CARBURETOR-A	1	WT-813A
26	T2070-42001	CRANKSHAFT-C	1		60	3306-81380	• SCREEN	1	
27	1650-43230	NUT	1	M8x1.0	61	3080-81120	• COVER	1	
28	1000-43240	KEY	1		62	3310-81130	• SCREW	1	
29	1140-43250	SIM	1		63	3304-81140	• GASKET	1	
30	1140-51111	SHOE	2		64	1172-81150	• DIAPHRAGM	1	
31	T2070-51220	SPRING (6000rpm IN)	1		65	1751-81470	• GASKET	1	
32	1140-51250	SCREW	2	M6x22L	66	3310-81260	• DIAPHRAGM	1	
33	1140-51230	WASHER	2		67	T2070-81210	• BODY-A	1	
34	1140-51242	WASHER	2		68	1751-81520	• COVER	1	

## G270RC (X374326111)

KEY#	PART NUMBER	DESCRIPTION	Q'TY/ UNIT	REMARKS	KEY#	PART NUMBER	DESCRIPTION	Q'TY/ UNIT	REMARKS
69	1751-81510	• PUMP	1		104	848ER883C0	• VALVE	1	
70	2867-81270	• SPRING	1		105	1918-82160	• WASHER	1	
71	3356-81310	• VALVE inlet	1		107	T2070-31111	COVER, FAN	1	
72	1480-81420	• PLUG welch	1		108	3310-12281	BOLT	4	M5x20L
73	3310-81230	• LEVER	1		109	T2070-32100	COVER-A	1	
74	3310-81240	• SCREW	1		110	1850-32160	SCREW	1	M4x12L
75	3310-81250	• PIN	1		111	1900-31410	SCREW	2	TP4.5x18L
76	2630-81330	• SCREW	1		112	3699-91867	SPARKPLUG NGK CMR7H	1	
77	3350-81380	• SPRING	1		113	T2070-72200	SWITCH-A	1	
78	848ETZ81T1	• SHAFT throttle	1		114	T2700-75410	LABEL, RECOIL	1	
79	2670-81410	• SPRING	1		116	1726-85004	TANK-A	1	OP
80	2880-81470	• SCREW	2		117	5601-85201	• CAP-A	1	OP
81	3310-81340	• VALVE throttle	1		118	1726-85601	• PIPE COMP	1	OP
82	3310-81360	• SCREW	1		119	5500-85400	• FILTER	1	OP
83	1790-81440	• LEVER throttle	1		120	1260-85460	• CLIP	1	OP
84	1148-81390	• RING	1		121	1799-85400	PIPE COMP	1	
86	2812-81510	• PISTON	1		122	5500-85400	FILTER	1	
87	2810-81530	• SPRING	1		123	1260-85460	CLIP	1	
88	2812-81520	• BALL	1		124	T3039-91310	SOCKET	1	
89	1148-81530	• SCREW	4		125	T2070-93112	MANUAL	1	
90	1491-81160	• SPRING	1		126	2890-96100	PULLER-A	1	OP
91	1148-81171	• NEEDLE low speed	1		127	4810-96220	STOPPER	1	OP
92	3080-81320	• SPRING	1		128	848ETZ7110	SPARKPLUG NGK CR8HIX with Terminal Nut	1	OP
93	T2070-81330	• NEEDLE high speed	1		129	1764-51220	SPRING (5000rpm IN)	1	OP
94	T2070-82510	SPACER	1		130	3699-91975	SPARKPLUGNGK CMR6H	1	OP
95	0263-90560	SCREW	2	M5x60L	131	3699-91809	SPARKPLUG Champion RZ7C	1	OP
98	848ER88300	CLEANER-A	1						
99	T1000-82110	• HOUSING	1						
100	5730-82040	• COVER	1						
101	1751-82020	• FILTER	1						
102	5730-82060	• SLEEVE	2						
103	848EP183Y0	• CLIP	1						

# WARRANTY

---

---

## WARRANTY TERMS

### 1) Scope of Application

This engine manufactured by Husqvarna Zenoah Co., Ltd. (herein after “Zenoah”). And sold to the user directly or through distributor/manufacturer, shall entitle to be covered by this warranty.

### 2) Limits of Warranty

Zenoah warrants that;

1. The quality disclosed in the specifications.
2. The engine which shall be considered defective by Zenoah, caused by material or production fault.

### 3) Limits of Compensation

1. Zenoah compensates such quality, material and production faults by repairing or replacing through distributor/manufacturer.
2. Zenoah shall not compensate any other accompanied or benefit losses caused to user and distributor/manufacturer by such faults and through repairing or replacing.

# WARRANTY

---

## 4) Term of Warranty

Three (3) months after purchased by end- user subject to 12 months from produced month.

## 5) Exempt from Warranty

Zenoah shall not warrant this engine even if the fault has been caused during the period of terms of Warranty, in case that.

1. Any faults, failures caused from neglect of proper operation and maintenance described in OWNER'S MANUAL.
2. Any modification not approved by Zenoah.
3. Normal abrasion and deterioration.
4. Consuming parts.
5. Using any parts which have not been certified by Zenoah.
6. Add-on or modified use.



Husqvarna Zenoah Co., Ltd.

Head Office : 1-9 Minamidai, Kawagoe-city, Saitama, 350-1165 Japan

Phone: (+81)49-243-1115 Fax: (+81)49-243-7197